

HUBAGM

The HB series sealed lead-acid batteries, use high purity lead and advanced battery separators, in the manufacturing process. Our advantages include long cycle life and high reliability. The battery technology improves the deep cycling ability and greatly prolongs battery life with more than 600 cycles at 80% DOD.

The HB series are best suited for cycling and solar applications.

TECHNICAL DRAWING

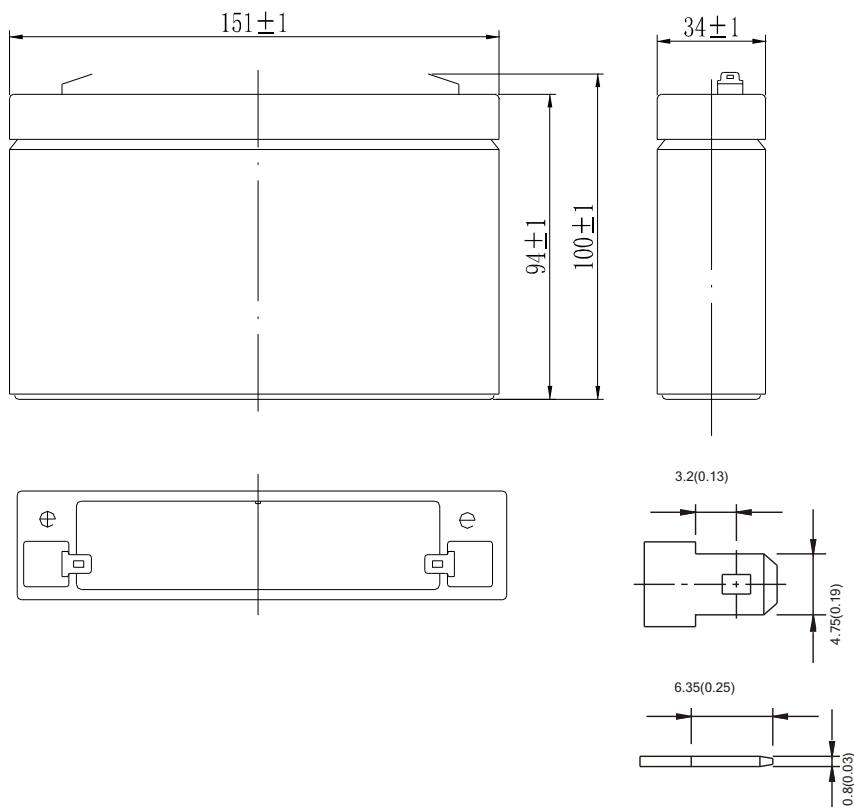

AGM

ABSORBED GLASS MAT
BATTERY

HB6-7

BENEFITS AND ADVANTAGES

Start at the Core

- Able to operate at -40°C to $+60^{\circ}\text{C}$
- DOD @ 50%, 1200 cycles
- Integrated design to ensure the best uniformity and reliability
- High purity lead, ensures long life and excellent performance
- IEC 60896, UL

APPLICATIONS

- Off Grid Cabins & Homes
- Marine / RV
- Hybrid Solar & Grid Tie
- Wheel Chairs, Golf Carts
- Telecom Systems
- Off-Grid Industrial
- Micro Grid Systems

www.hubpower.ca

4238 Lozells Ave #114 Burnaby, BC V5A 0C4

Phone: (604) 420-7737

Email: sales@hubpower.ca

ELECTRICAL SPECIFICATIONS

Nominal Voltage	6 V
Amp Hour Capacity C 20	7.00AH
Amp Hour Capacity C 48	7.28AH
Amp Hour Capacity C 72	7.47AH
Amp Hour Capacity C 100	7.77AH
Amp Hour Capacity C 120	7.92AH
Amp Hour Capacity C 240	8.10AH

TEMPERATURE SPECIFICATIONS

Cold temperature applications	
Discharge Temperature	(-40C)
Charge Temperature	(-40C)
Storage	-40C to 45C

CHARGE SPECIFICATIONS

Recommend Charge current	0.70A
Max Charge current	1.40A
Bulk Charge V	7.30V
Absorption V	7.30V
Float V	6.85V
Equalization V $\leq 20A$	7.30V

DISCHARGE SPECIFICATIONS

Current Discharge Rates	
20 hour rate	0.35A
10 hour rate	0.70A
5 hour rate	1.19A
1 hour rate	3.85A

MECHANICAL SPECIFICATIONS

Dimensions	5.94 x 1.34 x 3.98 in
L x W x H	151 x 34 x 101 mm
Weight	2.38lbs (1.08KG)
Terminal Type	F1
Terminal Material	Copper
Case Material	ABS
Case IP Rating	IP56
Cell Type - Chemistry	AGM
Cell Type	Flat Plate

SAFETY TESTED

Safety Ratings	IEC60896
	CE
	UL

PERFORMANCE CHARACTERISTICS

