

HUB LiION



LITHIUM
ION BATTERY

HUB-12.8V-20-LFP

TECHNICAL DRAWING

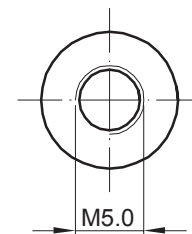
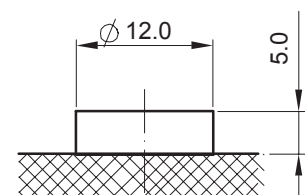
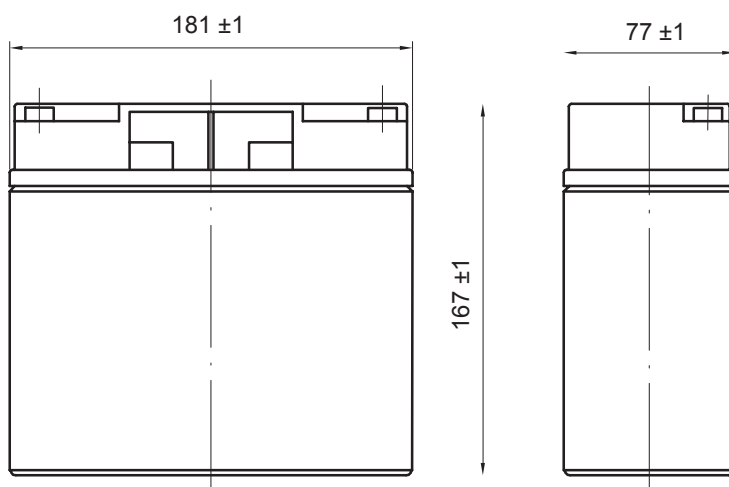
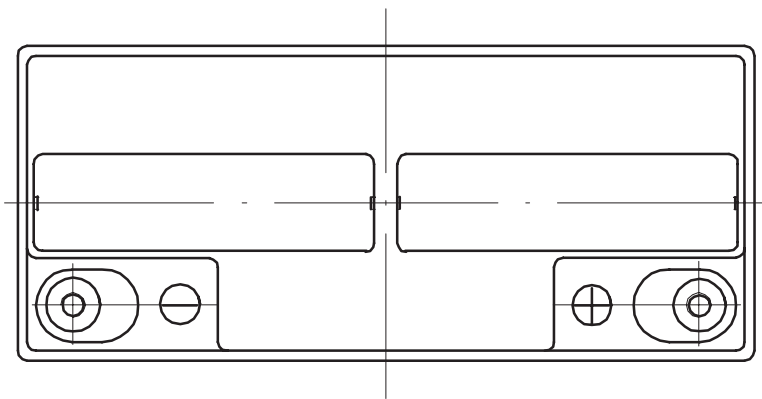

BENEFITS AND ADVANTAGES

Start at the Core

- High Reliability
- Fast and Efficient charge/discharge cycles
- Deep Discharge capability
- Fully Recycle capability
- Light weight
- Environmentally friendly
- UL Approved Cells
- Safety UN38.3 approved
- UN3480, CLASS 9

www.hubpower.ca

4238 Lozells Ave #114 Burnaby, BC V5A 0C4

Phone: (604) 420-7737

Email: sales@hubpower.ca

ELECTRICAL SPECIFICATIONS

Nominal Voltage	12.8V
Amp Hour Capacity	20AH
Reserve Capacity @ 20A	60 min
Energy Density	256Wh
Resistance - Milliohms	< 50
Efficiency - round trip	> 99.5%
Self Discharge per Month	< 3%
**Max 4 - series connections	12-48V
**Max 4 - parallel connections	20-80AH

**DO NOT configure series and parallel connections simultaneously

TEMPERATURE SPECIFICATIONS

Discharge Temperature	(-20 to 60C)
Charge Temperature	(0 to 45C)
Storage Temperature	(-5 to 35C)
BMS High Temp Cut Off	80C
BMS Reconnect Temp	50C

CHARGE SPECIFICATIONS

Recommend Charge current	2A - 5A
Max Charge current	10A
Charge current (0 to -10C)	<0.1C
Charge current (-20 to -10C)	<0.05C
Recommended Charge voltage	14.2 - 14.6V
BMS High voltage disconnect	15.0V
BMS High voltage reconnect	14.4V
Balancing voltage	≥13.6

PERFORMANCE CHARACTERISTICS

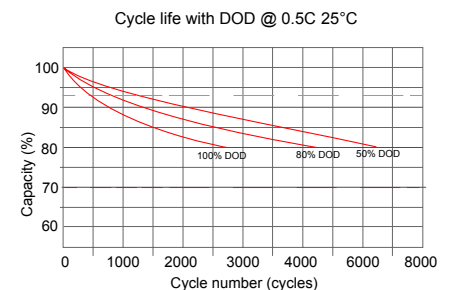
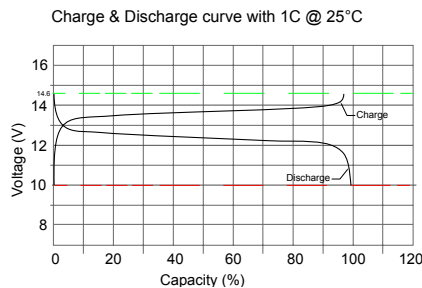
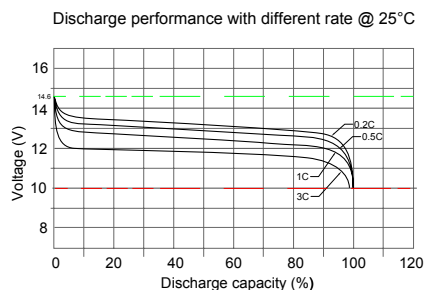

DISCHARGE SPECIFICATIONS

Max Cont Discharge current	20A
Peak Discharge Current 3C	60A
BMS Current Cut Off (10S)	>21A
BMS Current Cut Off (3S)	>30A
BMS Current Cut Off (1S)	>60A
BMS Low Voltage Cut Off	10V
BMS Low Reconnect Voltage	12V

MECHANICAL SPECIFICATIONS

Dimensions	7.13 x 3.03 x 6.57in
L x W x H	181 x 77x 167mm
Weight	6.61lbs (3KG)
Terminal Type	M8
Terminal Torque	90 in lbs (8NM)
Case Material	ABS
Case IP Rating	IP56
Cell Type - Chemistry	LiFePO4
Cell Type	Prismatic

SAFETY TESTED

Safety Ratings	CB / CE UN38.3 @ cell UL1973 @ cell
Shipping Classification	UN3480, CLASS 9